

Scharnier der mitte nur für höhe ≥ 1800
 Middle hinge only for height ≥ 1800
 Charnière du milieu uniquement pour hauteur ≥ 1800

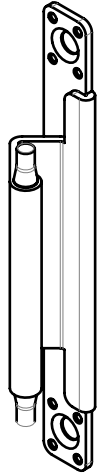

1 (4x < 1800)
 (6x ≥ 1800)

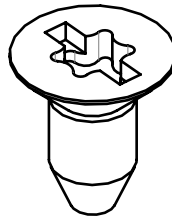

2 (8x < 1800)
 (12x ≥ 1800)

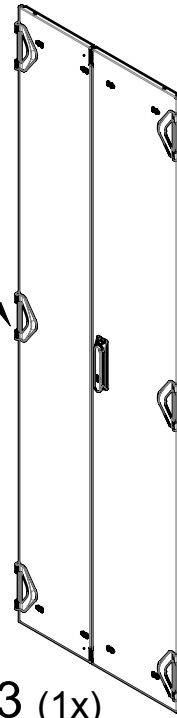

3 (1x)

D

EN

F

Sicherheit:

Für Bauteile oder Komponenten, die mehr als 25 kg wiegen, werden für die Montage und Demontage mindestens zwei Personen benötigt.

Montage:

Anziehdrehmoment sind mit einer Toleranz von $\pm 15\%$ angegeben, sofern nicht anders angegeben

Safety:

At least two persons are required to install or remove equipment or components which weight more than 25 kg.

Mounting:

Tightening torques are given with a tolerance of $\pm 15\%$ unless otherwise stated.

Sécurité:

Le montage et le démontage des équipements ou des composants d'une masse supérieure à 25 kg nécessitent au moins deux personnes.

Montage:

Les couples de serrages sont données avec une tolérance de $\pm 15\%$ sauf autres indications.

1

2000H
2200H
2450H

1 (1x)
2 (2x)
3.5Nm

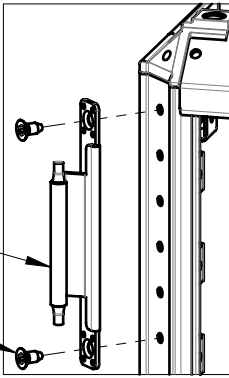

1200H
1400H
1600H
1800H

1 (1x)
2 (2x)
3.5Nm

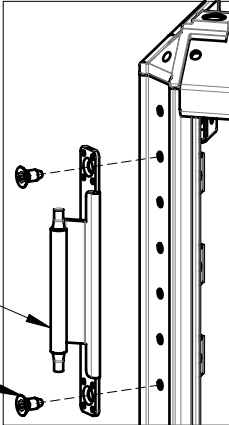

2000H
2200H
2450H

1 (1x)
2 (2x)
3.5Nm

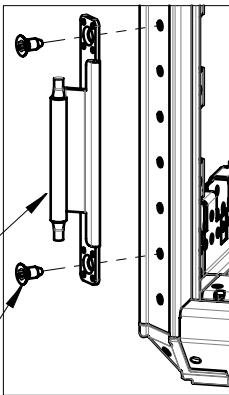

1200H
1400H
1600H
1800H

1 (1x)
2 (2x)
3.5Nm

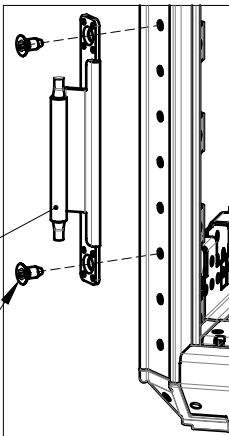

Nur für höhe \geq 1800
Only for height \geq 1800
Uniquement pour hauteur \geq 1800

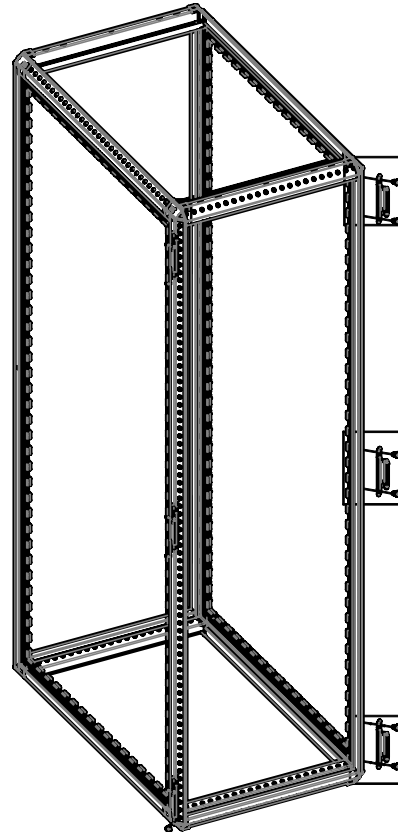
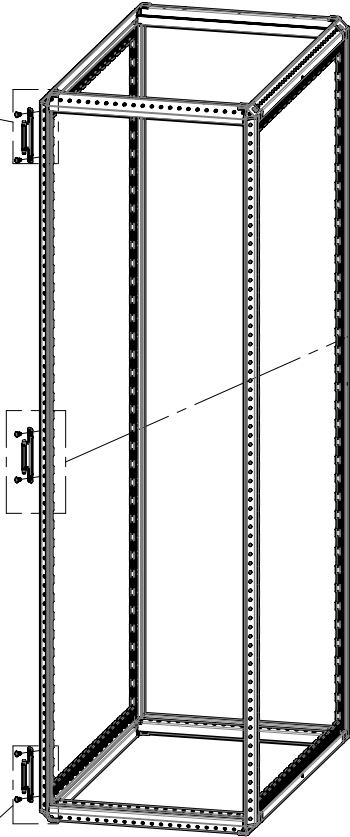
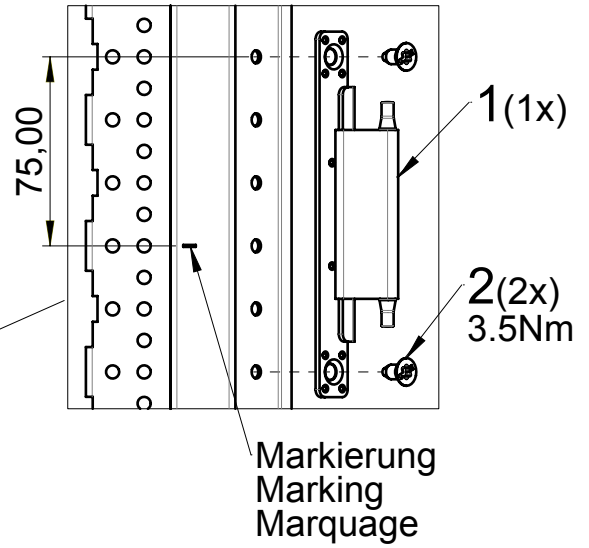

Wiederholen Sie die Montage symmetrisch auf der rechten Seite

Repeat the assembly symmetrically on the right

Répéter le montage symétriquement à droite

2

